

側面図

参考重量 977kg

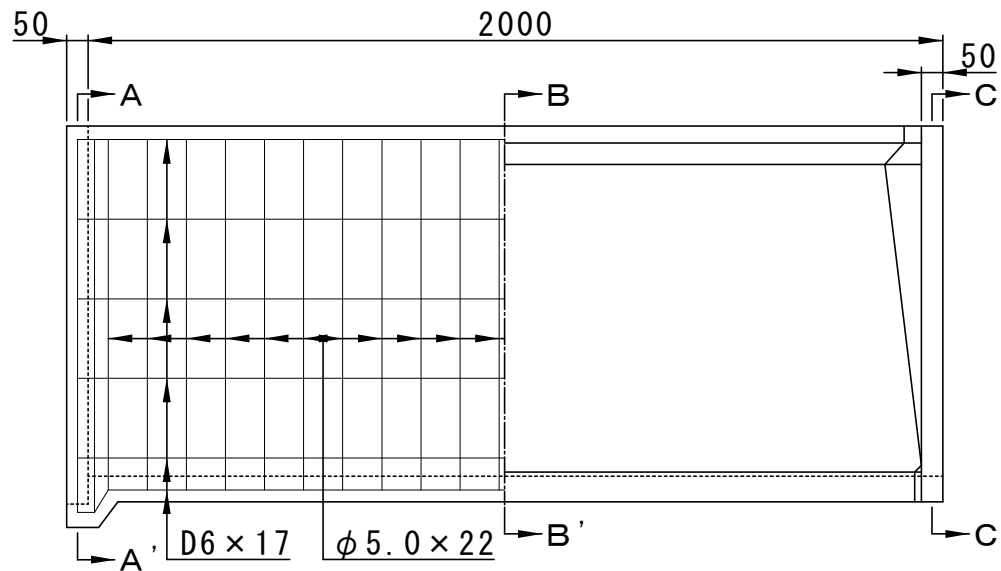

A-A' 断面

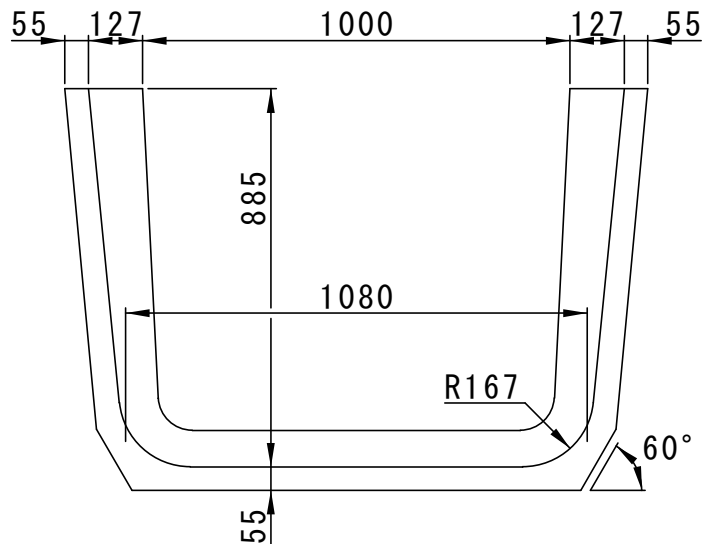

B-B' 断面

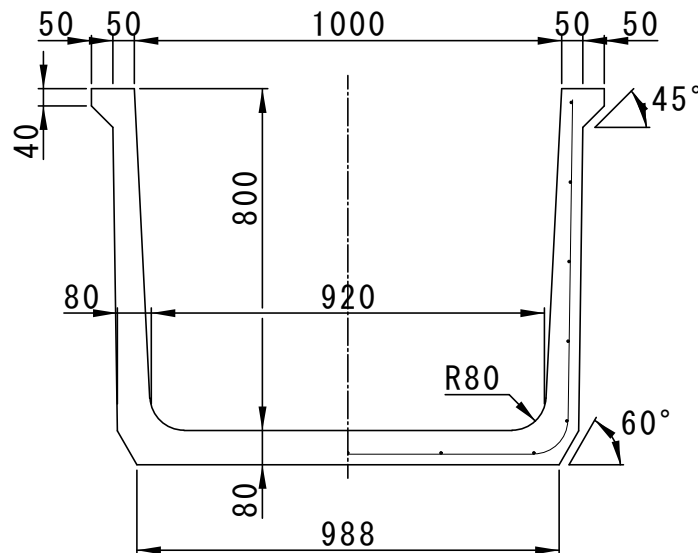

C-C' 断面

