

1st タッチウォール(F型) H=900

参考重量 725kg

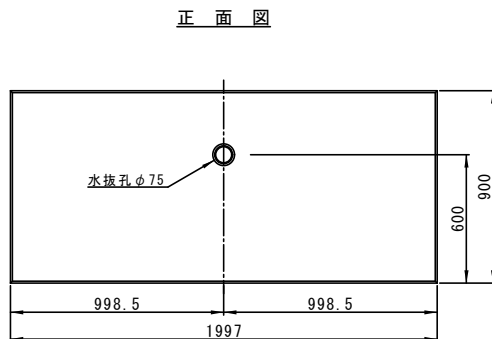

配筋図(底板)

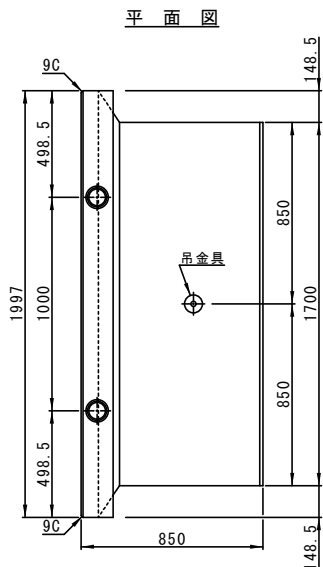
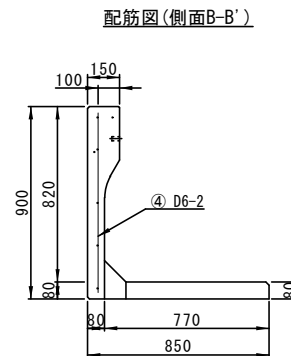
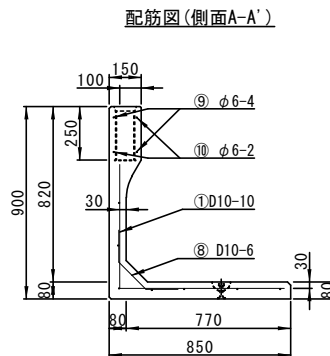
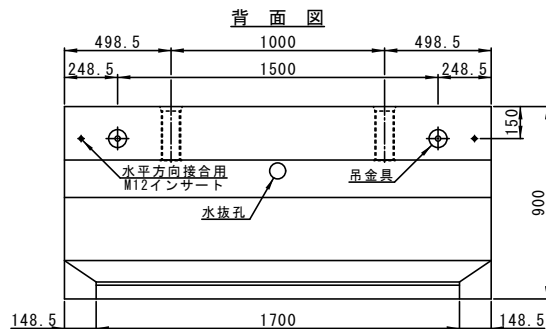
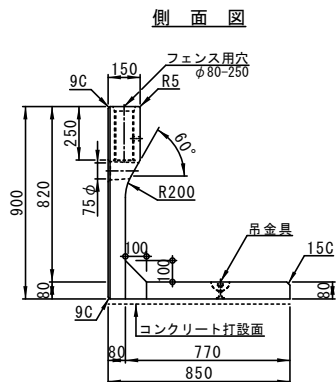
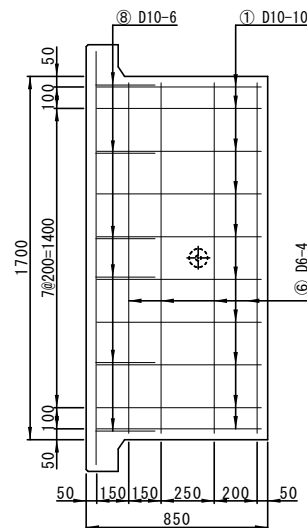

配筋図(縦壁)

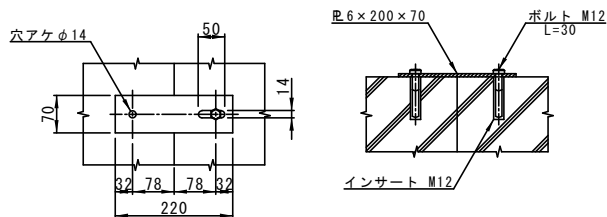
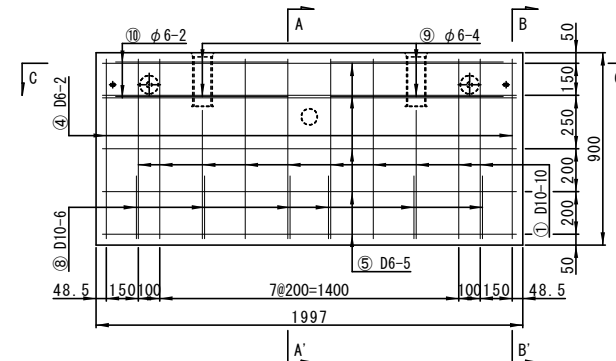

継手金具詳細図 S=1/11

縦壁断面図詳細(C-C')

