

ロードウォール H=2000 構造図

側面図

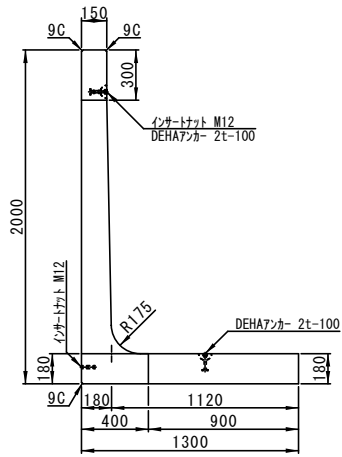

縦壁 (背面)

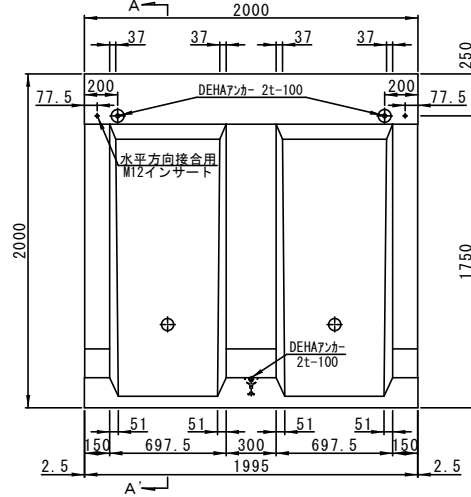

縦壁 (前面)

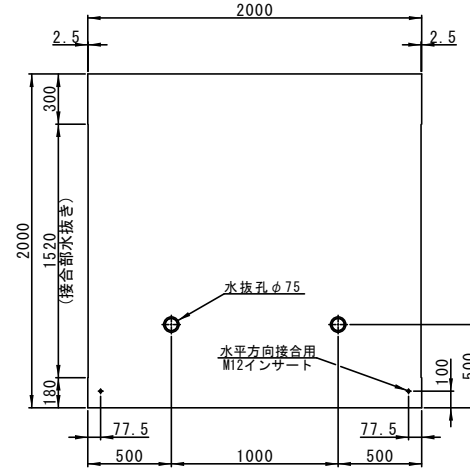

製品	コンクリート	$\sigma_{ck} = 30 \text{ N/mm}^2$
体積		0.710 m ³
質量		1.700 kg

断面 A-A'

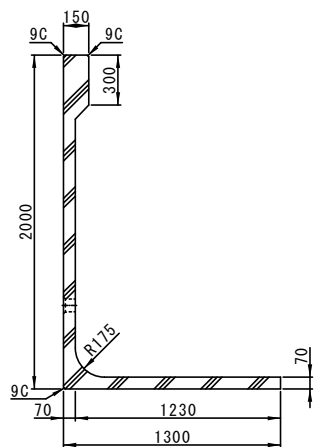

底板 (上面)

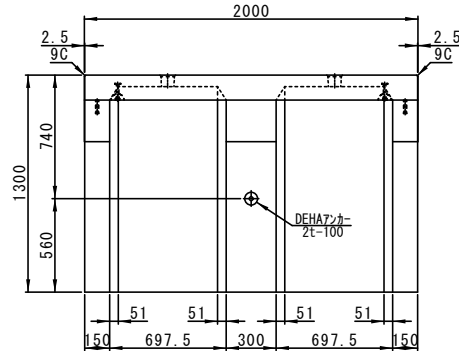

底板 (下面)

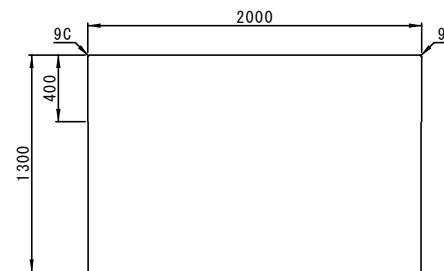

継手金具詳細図 S=1/11

