

参考重量 65kg

正面図

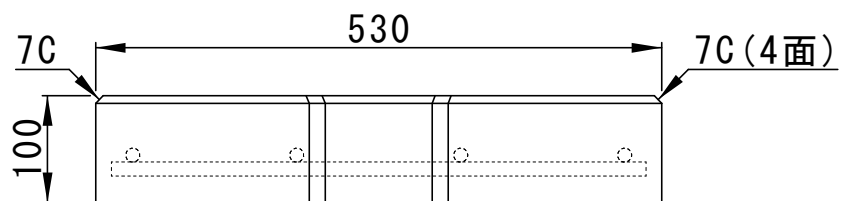

平面図

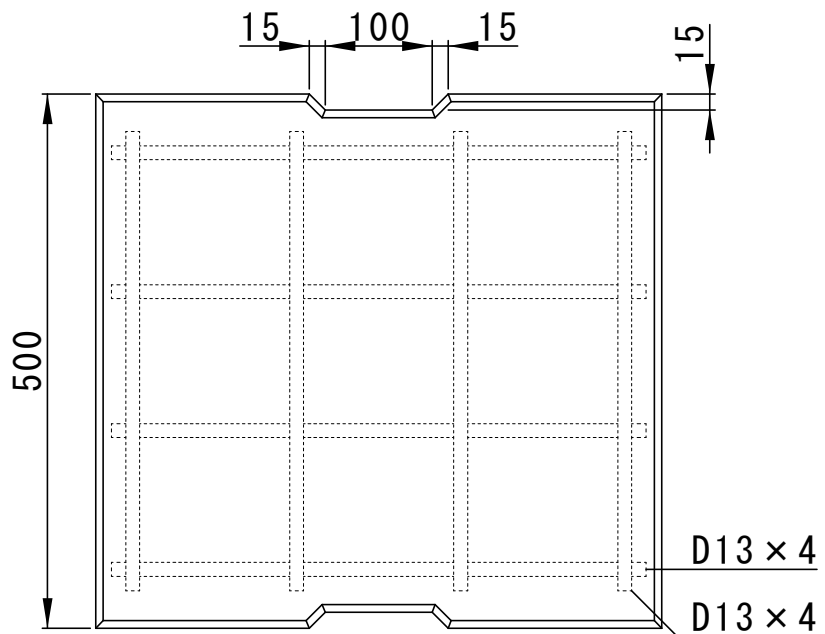

側面図

