

参考重量 2,144kg

正面図

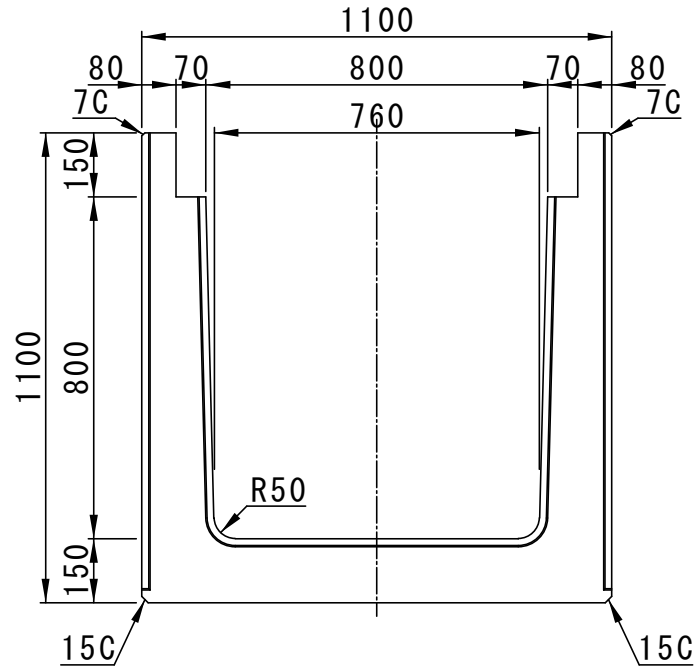

側面図

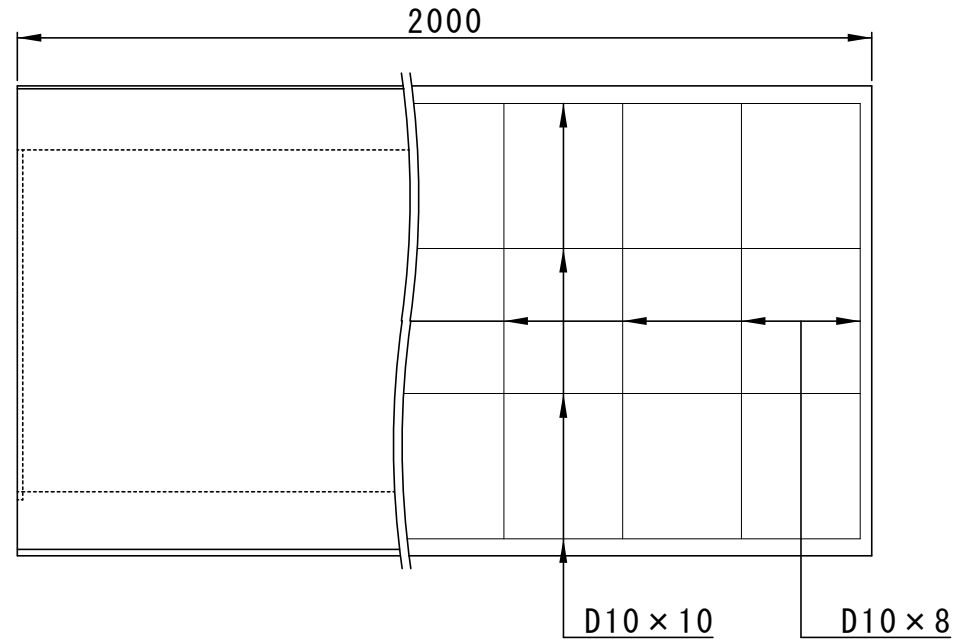

配筋図

