

参考重量 1,980kg

正面図

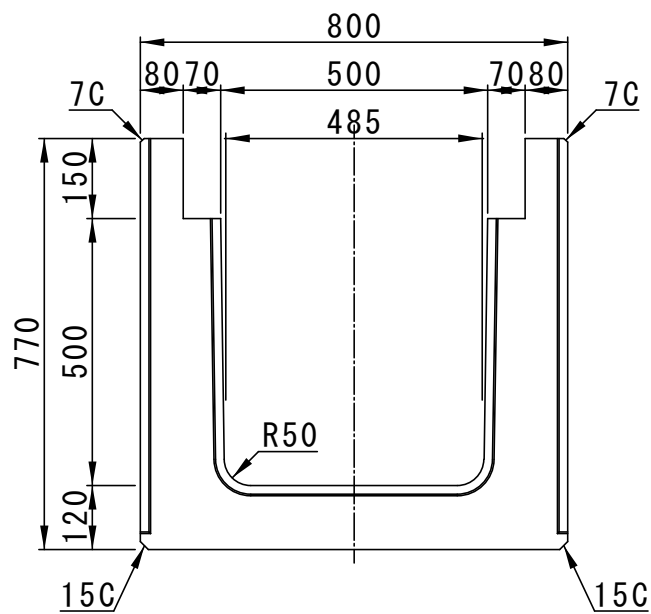

側面図

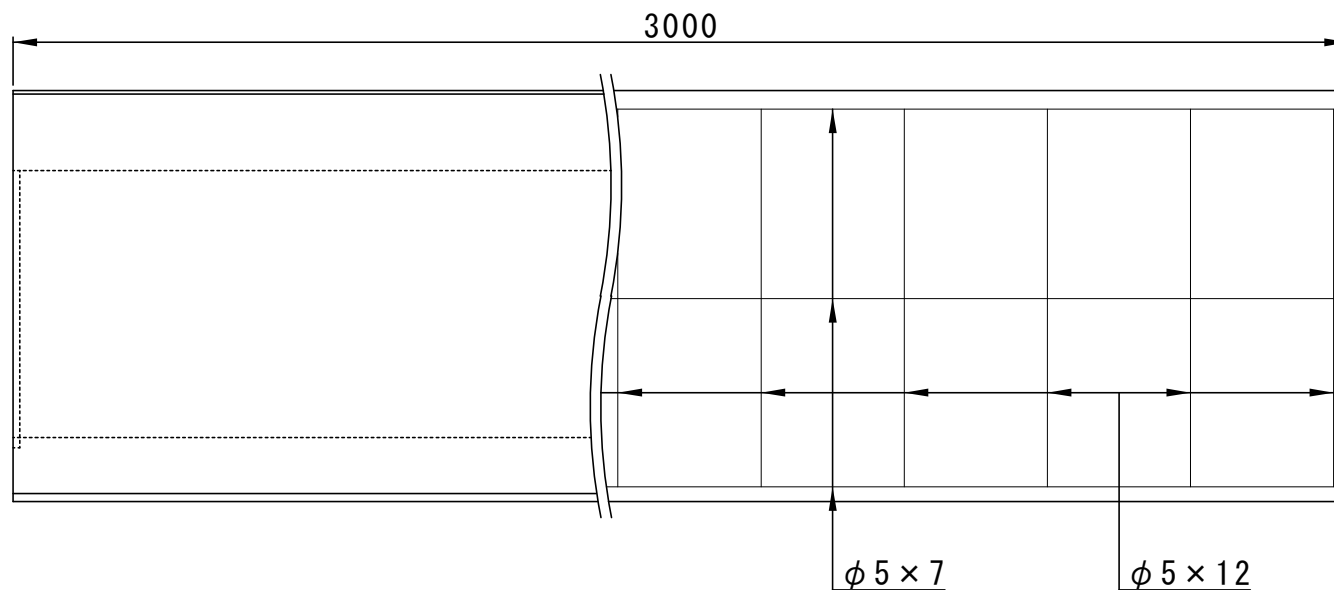

配筋図

