

参考重量 2,188kg

正面図

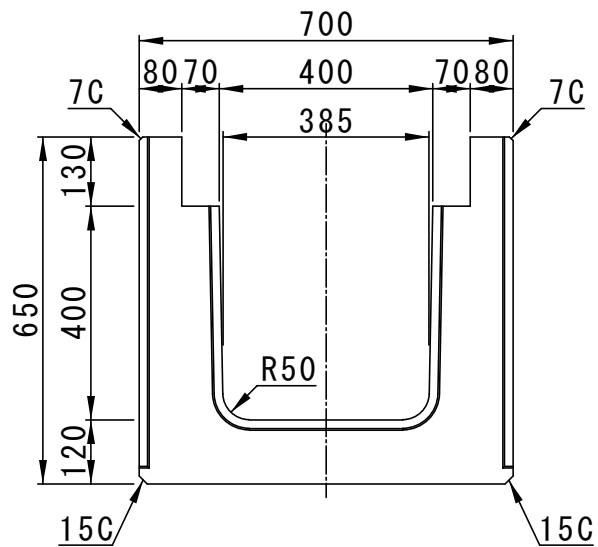

側面図

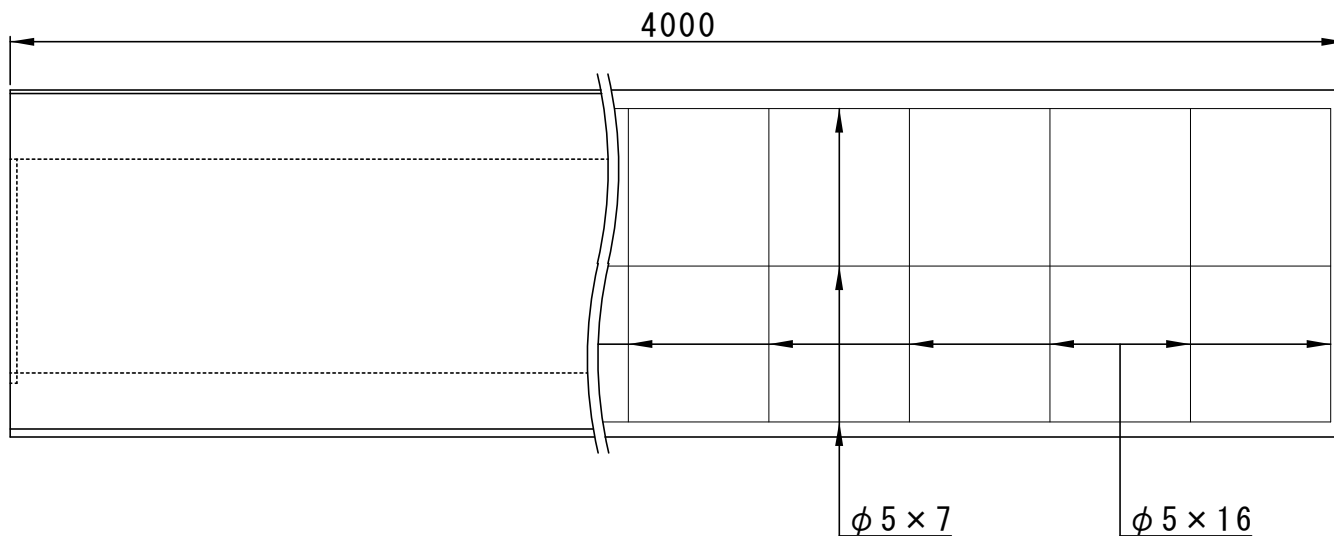

配筋図

