

参考重量 32kg

正面図

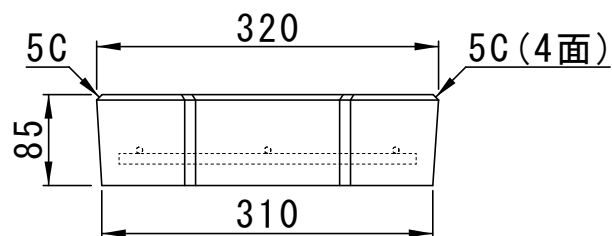

平面図

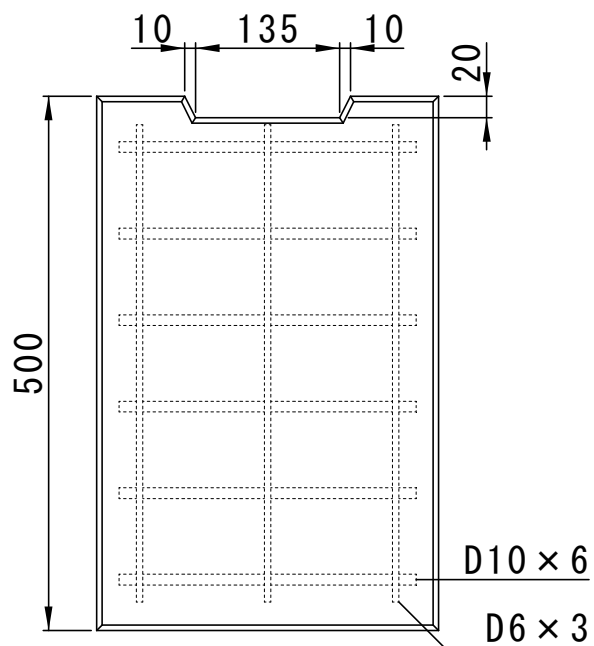

側面図

