

正面図

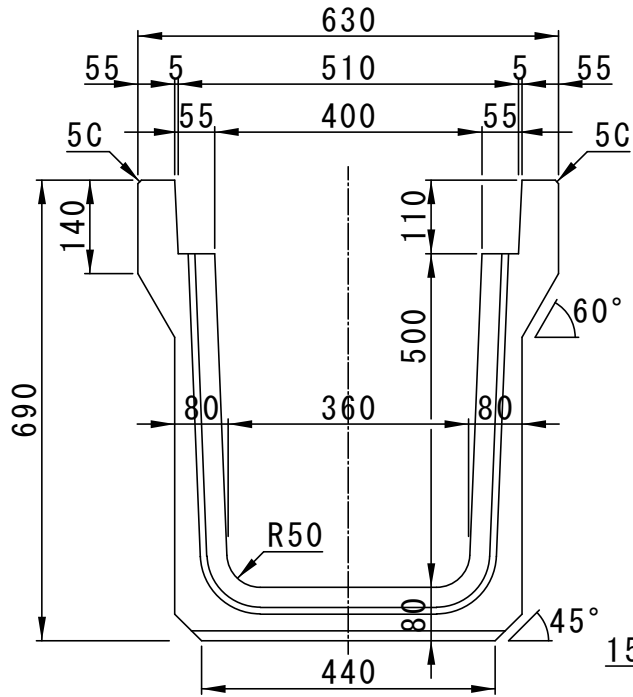

参考重量 621kg

側面図

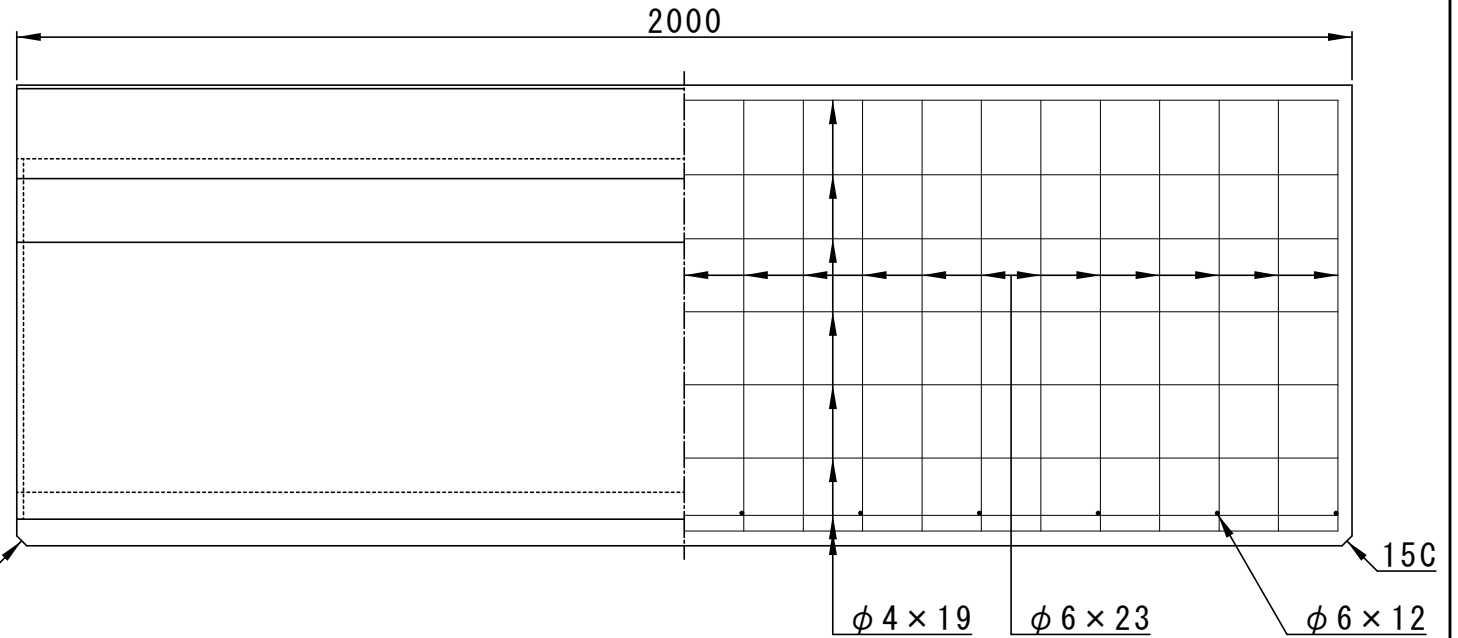

配筋図

