

参考重量 78kg

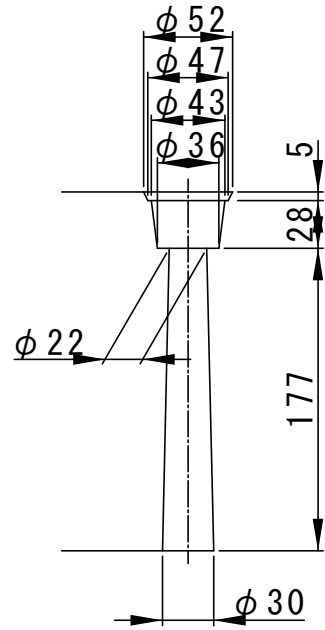

ボルト孔詳細

平面図

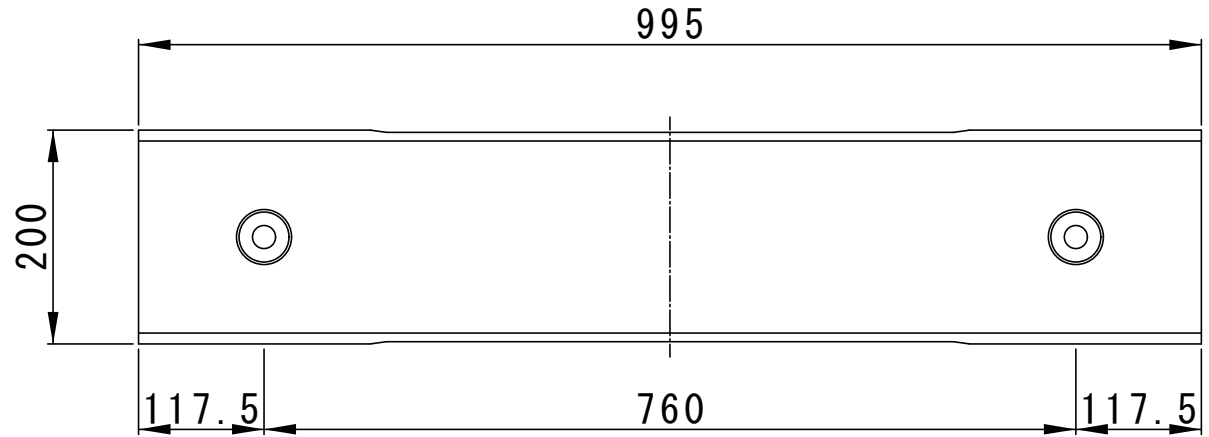

正面図

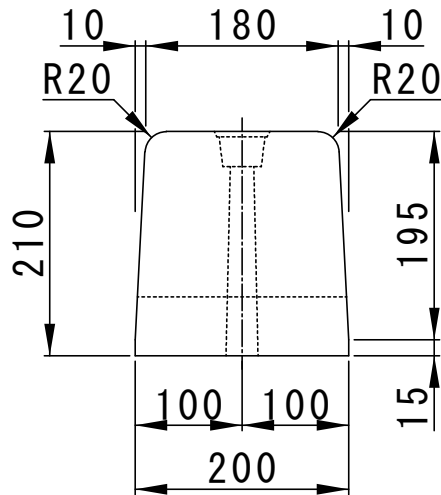

側面図

